

This product is intended for installation only by expert users. Please consult with a qualified technician for installation. Improper installation may result in damage to your equipment.

Before you start using this product please follow these basic guidelines:

1. Please carefully read through the instruction manual before beginning the installation process.
2. Please remove your graphics card from your motherboard to insure the safest process and in order to prevent any possible damages to your CPU and motherboard.
3. It is strongly recommended to use market proven pre-mix coolant, such as Thermaltake Coolant 1000.

Parts List

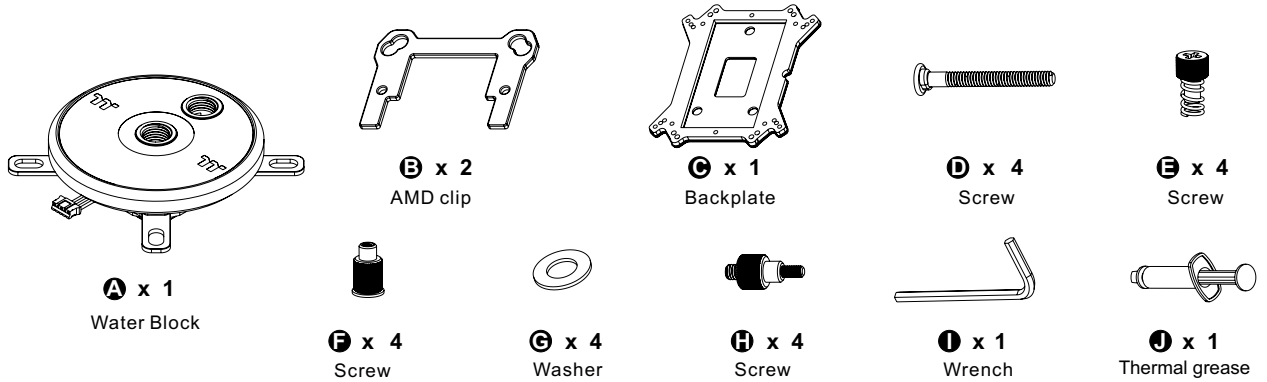

Intel LGA 775, LGA115x, LGA1366

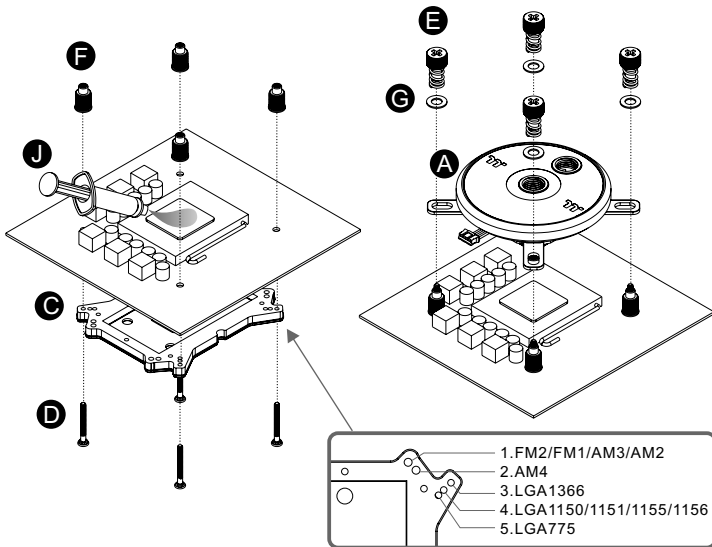

Intel LGA2066, 2011-3, 2011

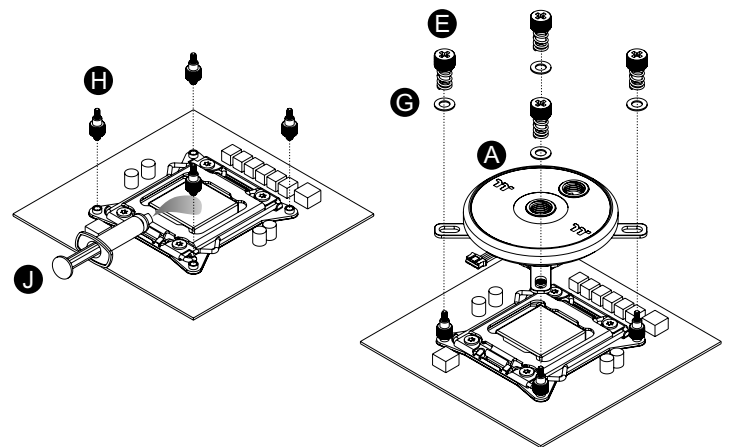

AMD

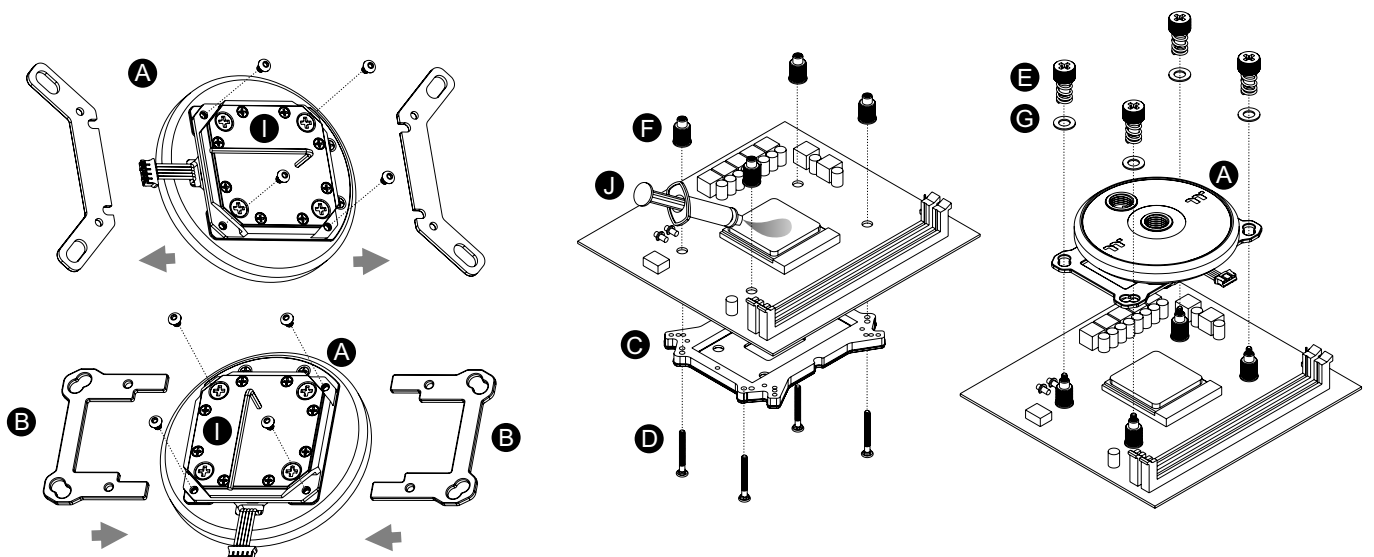

Controller Parts List

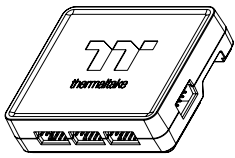

K x 1
Controller

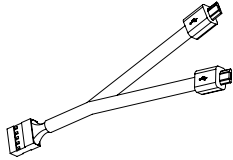

L x 1
Controller Cable

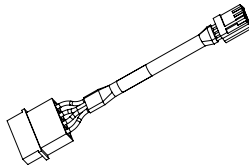

M x 1
Power Cable

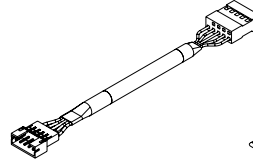

N x 1
Conversion Cable

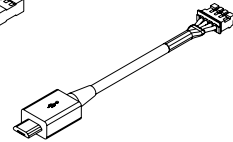

O x 1
Bridge Cable

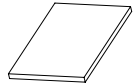

P x 1
Velcro

Installation Guide

1

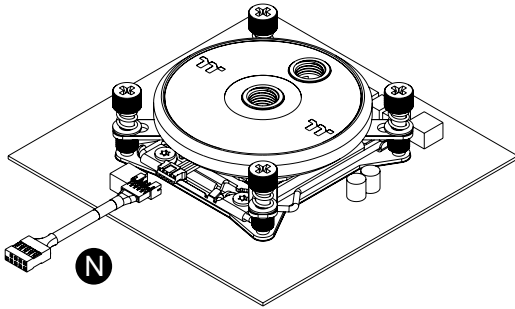

Install the Water Block on the mainboard properly, and connect the water block cable to the conversion cable.

2

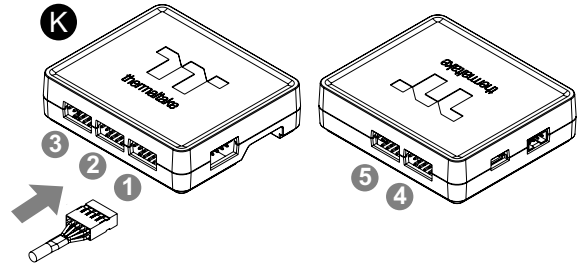

Connect the plug into the port in numerical order, start with plug one.

3

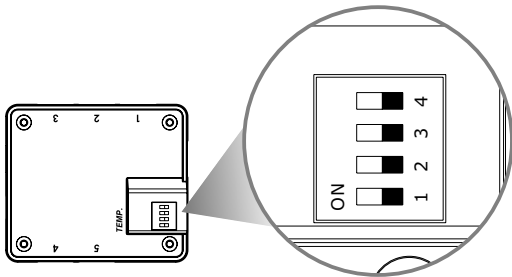

Set the DIP switch on the back side of the controller to assign the number of the controller

4

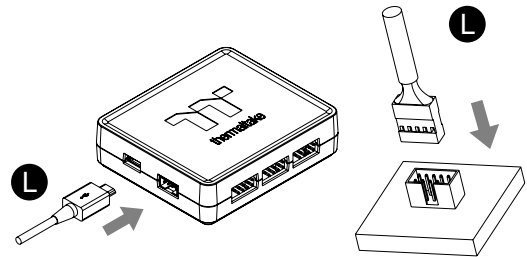

Connect the controller cable onto the mainboard (USB 2.0 9 pin) and controller.

5

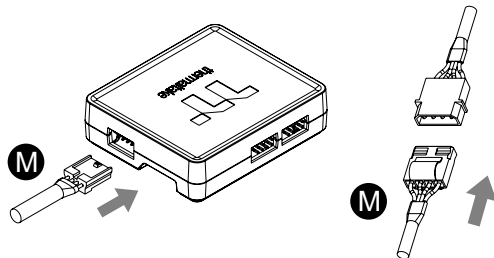

Connect the power cable to the 4pin Molex connector and controller.

6

Connect with other addressable LED product

TEMP. Controller Plus Controller Trio Controller

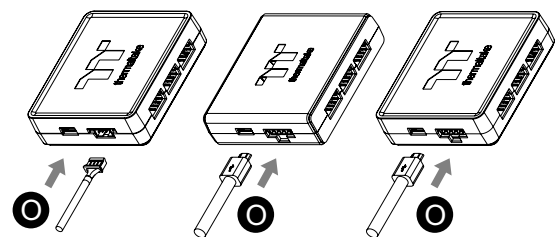

1. Pacific W5 is only compatible with Temp controller
2. Connect the controller cable to Temp controller, and then connect the rest of controllers in series

NO.1

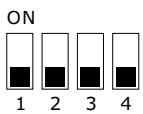

NO.2

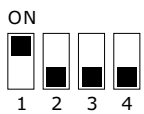

NO.3

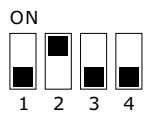

NO.4



NO.5

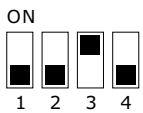

NO.6

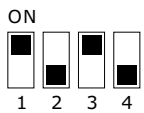

NO.7

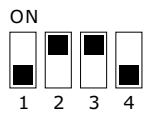

NO.8



NO.9

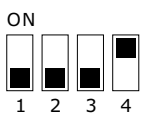

NO.10

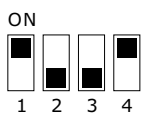

NO.11



NO.12

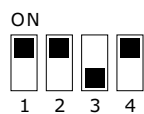

NO.13

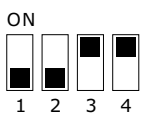

NO.14

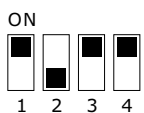

NO.15



NO.16

